

RN326-E-MPBX INA

Cylindrical roller bearings

TYPE: Roller bearings, Cylindrical roller bearings, Single row, Without outer ring, With cage

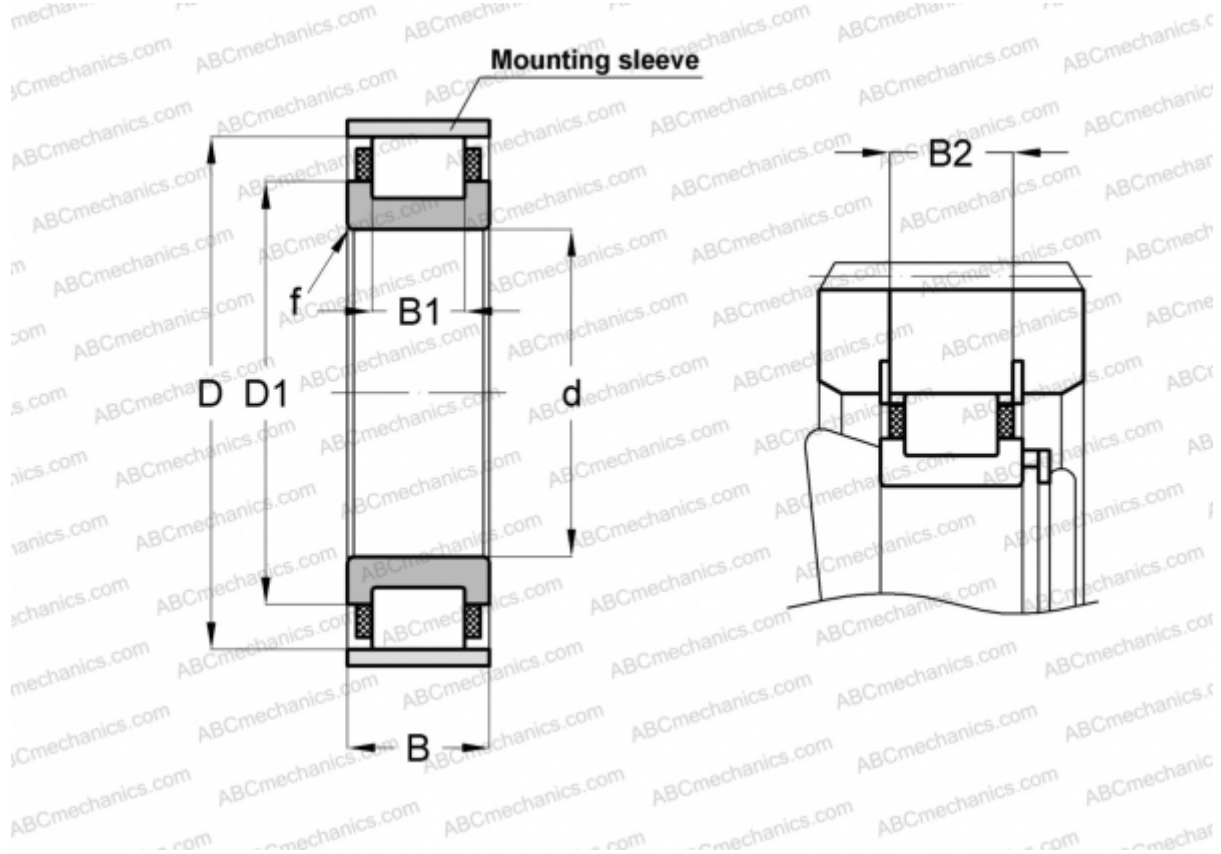

Technical specification

DIMENSIONS, MM

d	130,000
D	247,000
D1	181,700
B	58,000
B1	40,000
B2	54,700
f	4,000

WEIGHT, KG 11,800

MANUFACTURER [INA](#)

ASSOCIATED PRODUCTS

SB250 3X5