

RN2207-E-MPBX INA

Cylindrical roller bearings

TYPE: Roller bearings, Cylindrical roller bearings, Single row, Without outer ring, With cage

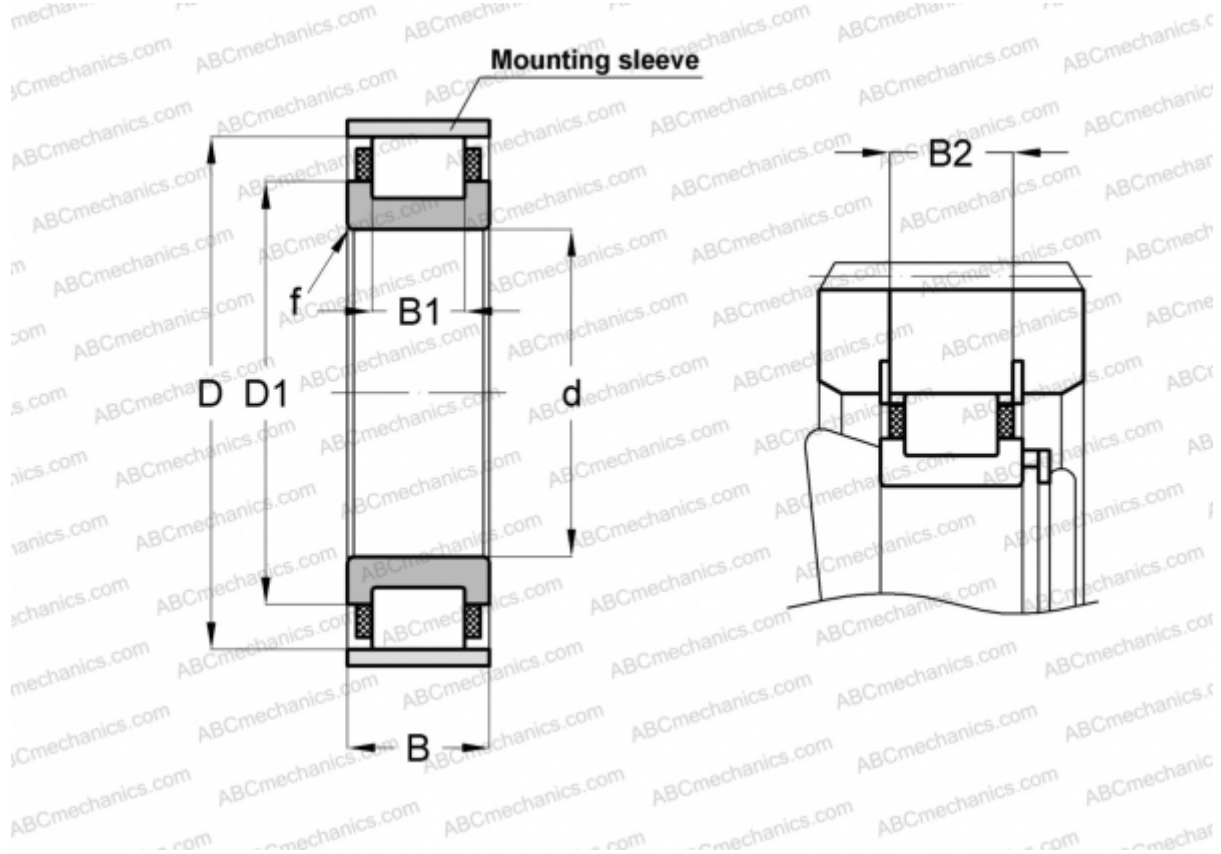

Technical specification

DIMENSIONS, MM

d	35,000
D	64,000
D1	48,000
B	23,000
B1	14,000
B2	21,200
f	1,100

WEIGHT, KG 0,270

MANUFACTURER [INA](#)

ASSOCIATED PRODUCTS

SB65 1,5X2,3