

RN2224-E-MPBX INA

Cylindrical roller bearings

TYPE: Roller bearings, Cylindrical roller bearings, Single row, Without outer ring, With cage

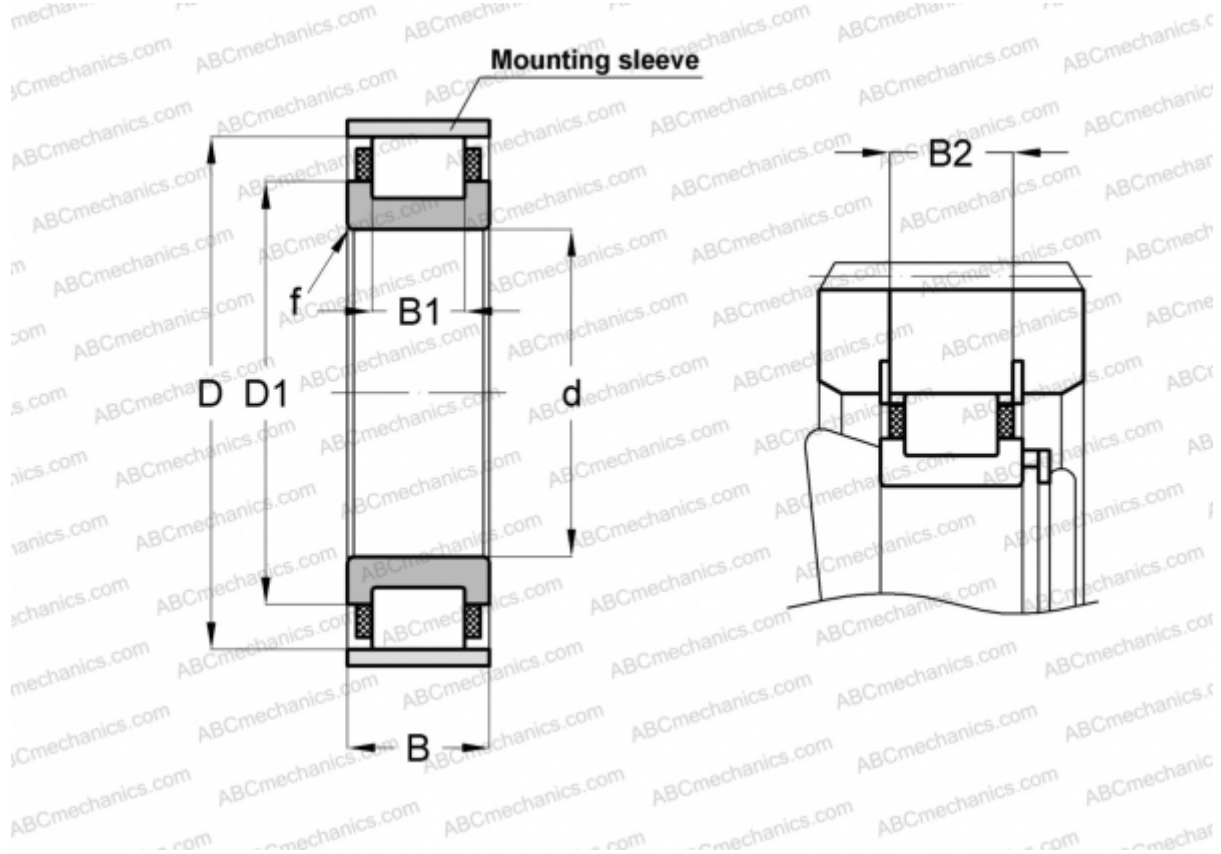

Technical specification

DIMENSIONS, MM

d	120,000
D	195,500
D1	153,200
B	58,000
B1	40,000
B2	54,700
f	2,100

WEIGHT, KG 6,520

MANUFACTURER [INA](#)

ASSOCIATED PRODUCTS

SB195 3X5