

RN2234-E-MPBX INA

Cylindrical roller bearings

TYPE: Roller bearings, Cylindrical roller bearings, Single row, Without outer ring, With cage

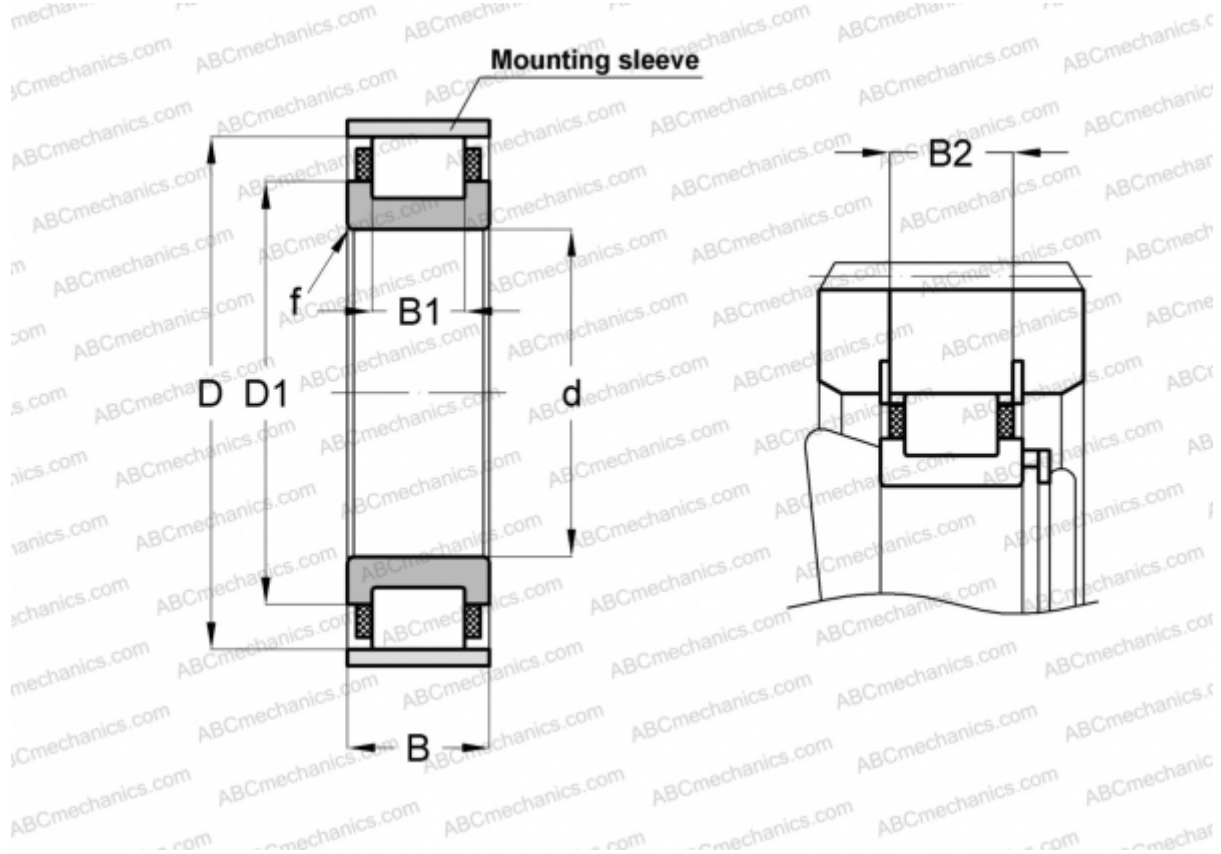

Technical specification

DIMENSIONS, MM

d	170,000
D	279,000
D1	219,000
B	86,000
B1	62,000
B2	81,700
f	4,000

WEIGHT, KG 19,500

MANUFACTURER [INA](#)

ASSOCIATED PRODUCTS

SB280 4X7,5