

RN2305-E-MPBX INA

Cylindrical roller bearings

TYPE: Roller bearings, Cylindrical roller bearings, Single row, Without outer ring, With cage

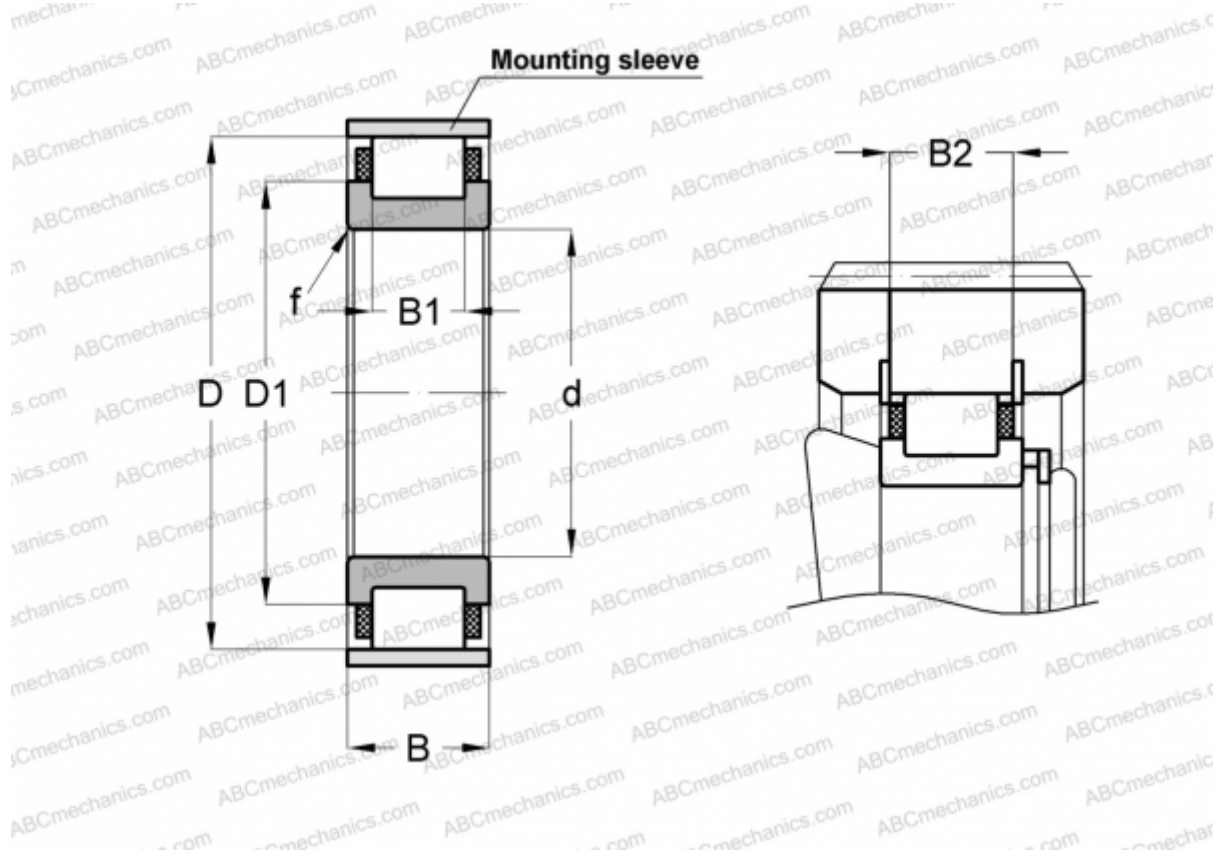

Technical specification

DIMENSIONS, MM

d	25,000
D	54,000
D1	38,100
B	24,000
B1	16,000
B2	22,200
f	1,100

WEIGHT, KG 0,231

MANUFACTURER [INA](#)

ASSOCIATED PRODUCTS

SB55 1,5X2,3