

RN2307-E-MPBX INA

Cylindrical roller bearings

TYPE: Roller bearings, Cylindrical roller bearings, Single row, Without outer ring, With cage

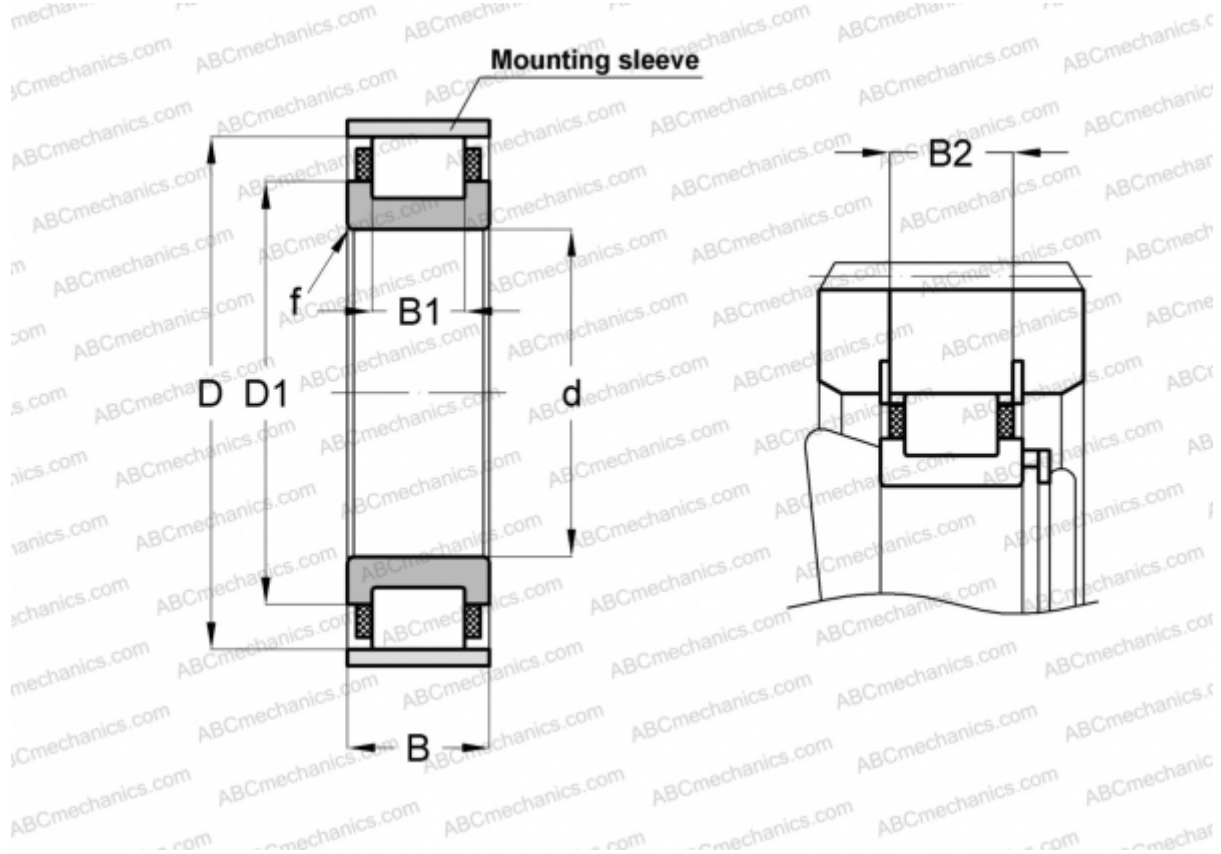

Technical specification

DIMENSIONS, MM

d	35,000
D	70,200
D1	51,000
B	31,000
B1	21,000
B2	29,200
f	1,500

WEIGHT, KG 0,480

MANUFACTURER [INA](#)

ASSOCIATED PRODUCTS

SB70 1,5X2,3