

RN2309-E-MPBX INA

Cylindrical roller bearings

TYPE: Roller bearings, Cylindrical roller bearings, Single row, Without outer ring, With cage

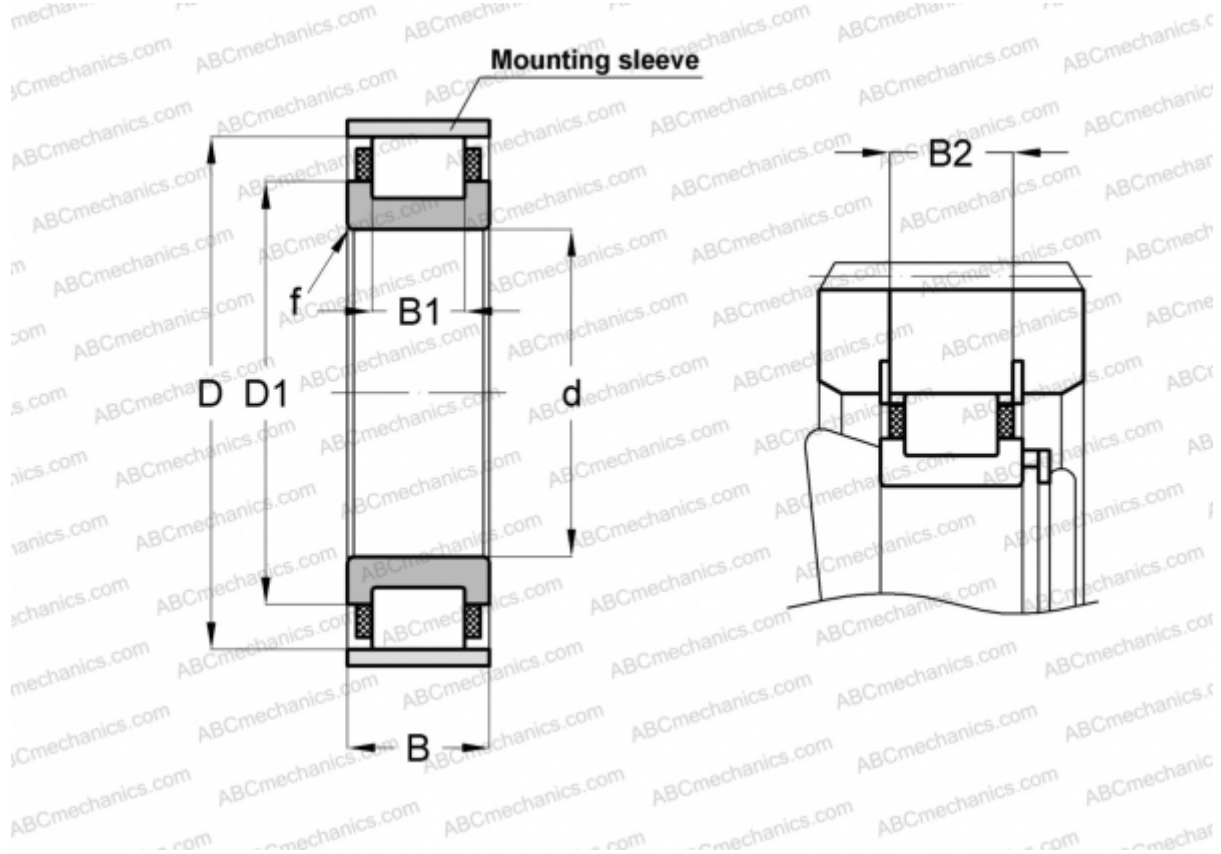

Technical specification

DIMENSIONS, MM

d	45,000
D	88,500
D1	64,400
B	36,000
B1	24,000
B2	33,200
f	1,500

WEIGHT, KG 0,890

MANUFACTURER [INA](#)

ASSOCIATED PRODUCTS

SB90 2,5X3,4