

RN2330-E-MPBX INA

Cylindrical roller bearings

TYPE: Roller bearings, Cylindrical roller bearings, Single row, Without outer ring, With cage

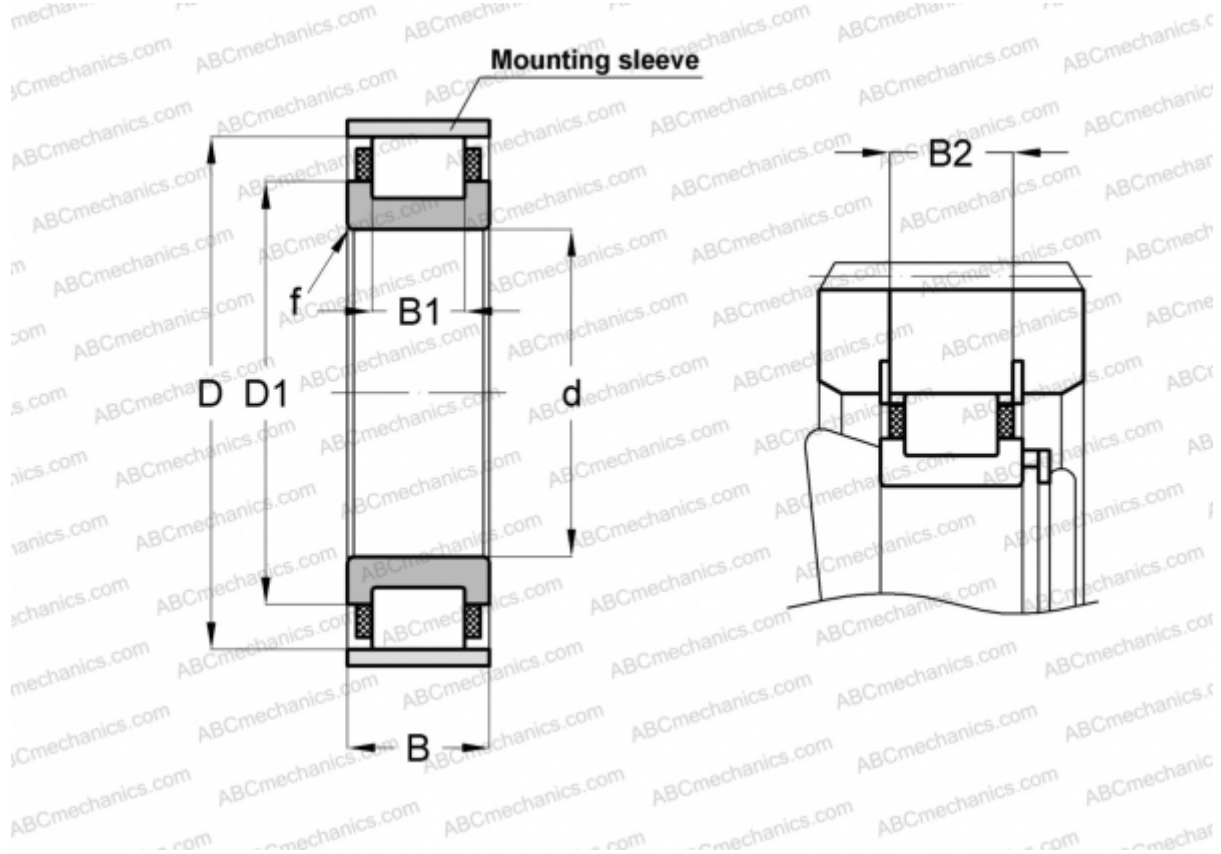

Technical specification

DIMENSIONS, MM

d	150,000
D	283,000
D1	209,500
B	108,000
B1	75,000
B2	103,700
f	4,000

WEIGHT, KG 27,400

MANUFACTURER [INA](#)

ASSOCIATED PRODUCTS

SB280 4X7,5