

## SL06016 E INA

Cylindrical roller bearings

TYPE: Roller bearings, Cylindrical roller bearings, Double row, Non-locating bearing, full complement cylindrical roller set, spherical outer ring

### Technical specification

#### DIMENSIONS, MM

d	80,000
D	240,000
D1	120,000
B	55,000

#### WEIGHT, KG

1,800

#### MANUFACTURER

[INA](#)

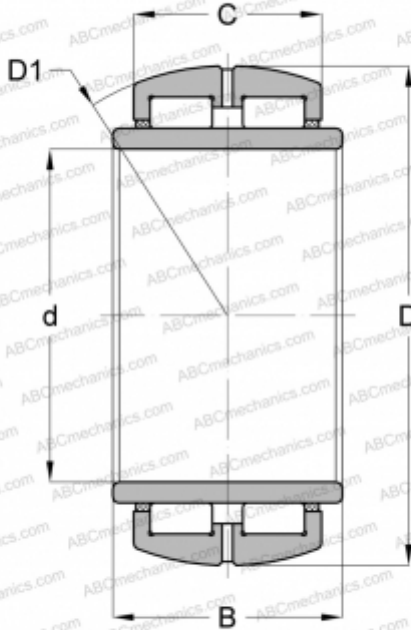

#### ASSOCIATED PRODUCTS

GG51120