

SL06020 E INA

Cylindrical roller bearings

TYPE: Roller bearings, Cylindrical roller bearings, Double row, Non-locating bearing, full complement cylindrical roller set, spherical outer ring

Technical specification

DIMENSIONS, MM

d	100,000
D	300,000
D1	150,000
B	65,000

WEIGHT, KG

3,450

MANUFACTURER

[INA](#)

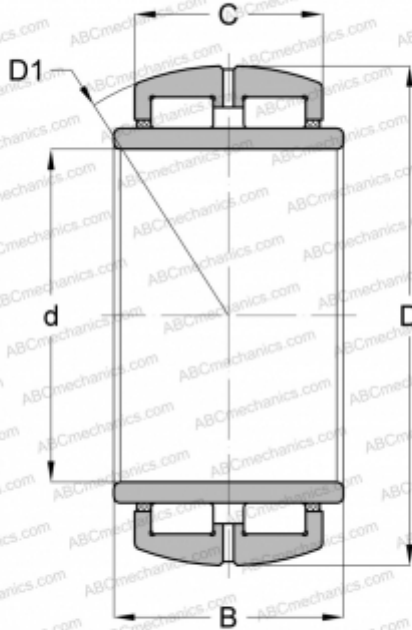

ASSOCIATED PRODUCTS

GG51150