

SL06022 E INA

Cylindrical roller bearings

TYPE: Roller bearings, Cylindrical roller bearings, Double row, Non-locating bearing, full complement cylindrical roller set, spherical outer ring

Technical specification

DIMENSIONS, MM

d	110,000
D	340,000
D1	170,000
B	75,000

WEIGHT, KG

5,200

MANUFACTURER

[INA](#)

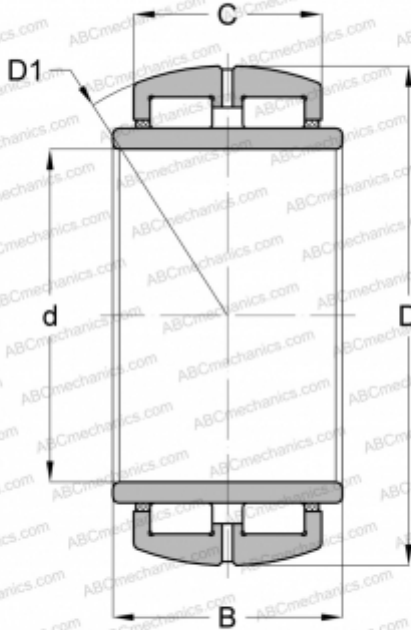

ASSOCIATED PRODUCTS

GG51170