

SL06024 E INA

Cylindrical roller bearings

TYPE: Roller bearings, Cylindrical roller bearings, Double row, Non-locating bearing, full complement cylindrical roller set, spherical outer ring

Technical specification

DIMENSIONS, MM

d	120,000
D	360,000
D1	180,000
B	75,000

WEIGHT, KG

5,500

MANUFACTURER

[INA](#)

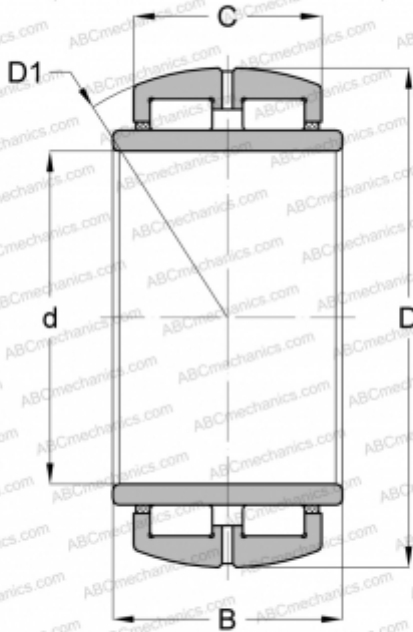

ASSOCIATED PRODUCTS

GG51180