

SL06028 E INA

Cylindrical roller bearings

TYPE: Roller bearings, Cylindrical roller bearings, Double row, Non-locating bearing, full complement cylindrical roller set, spherical outer ring

Technical specification

DIMENSIONS, MM

d	140,000
D	420,000
D1	210,000
B	85,000

WEIGHT, KG

8,550

MANUFACTURER

[INA](#)

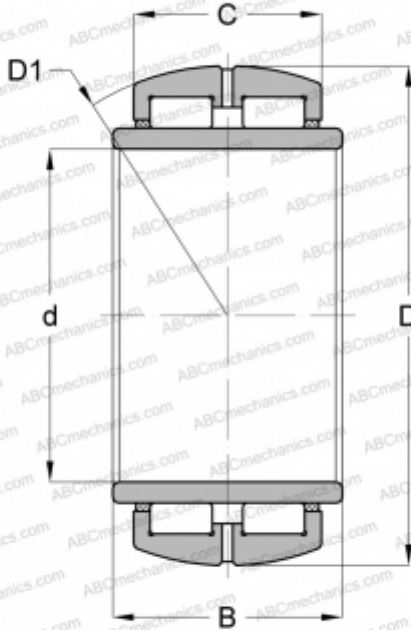

ASSOCIATED PRODUCTS

GG51210