

## SL06030 E INA

Cylindrical roller bearings

TYPE: Roller bearings, Cylindrical roller bearings, Double row, Non-locating bearing, full complement cylindrical roller set, spherical outer ring

### Technical specification

#### DIMENSIONS, MM

d	150,000
D	450,000
D1	225,000
B	90,000

#### WEIGHT, KG

10,500

#### MANUFACTURER

[INA](#)

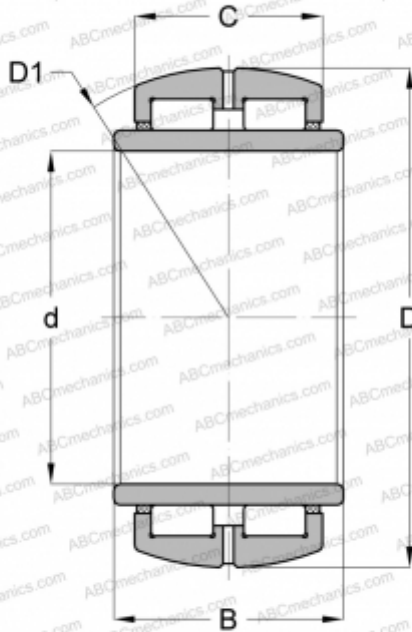

#### ASSOCIATED PRODUCTS

GG51225