

SL06034 E INA

Cylindrical roller bearings

TYPE: Roller bearings, Cylindrical roller bearings, Double row, Non-locating bearing, full complement cylindrical roller set, spherical outer ring

Technical specification

DIMENSIONS, MM

d	170,000
D	520,000
D1	260,000
B	115,000

WEIGHT, KG

18,100

MANUFACTURER

[INA](#)

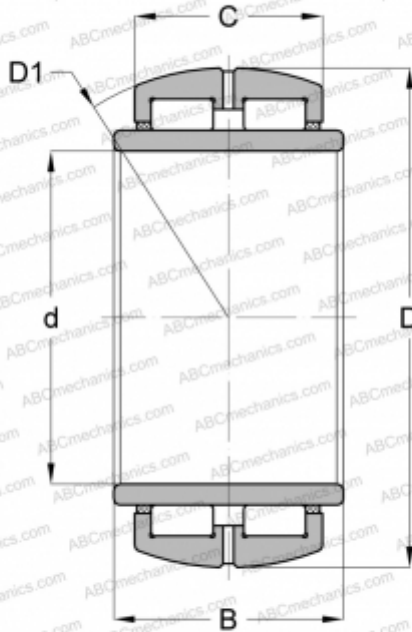

ASSOCIATED PRODUCTS

GG51260