

SL06036 E INA

Cylindrical roller bearings

TYPE: Roller bearings, Cylindrical roller bearings, Double row, Non-locating bearing, full complement cylindrical roller set, spherical outer ring

Technical specification

DIMENSIONS, MM

d	180,000
D	560,000
D1	280,000
B	120,000

WEIGHT, KG

23,000

MANUFACTURER

[INA](#)

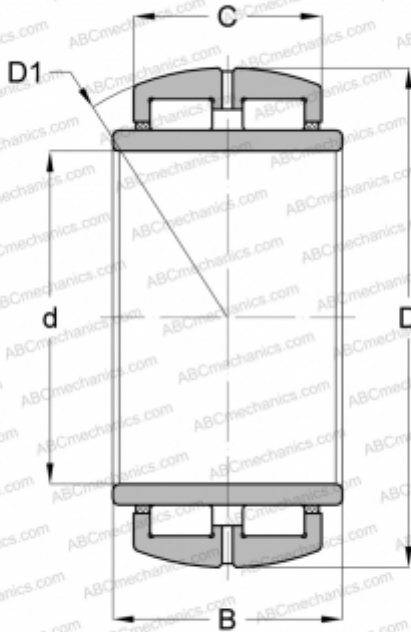

ASSOCIATED PRODUCTS

GG51280