

SL06038 E INA

Cylindrical roller bearings

TYPE: Roller bearings, Cylindrical roller bearings, Double row, Non-locating bearing, full complement cylindrical roller set, spherical outer ring

Technical specification

DIMENSIONS, MM

d	190,000
D	580,000
D1	290,000
B	135,000

WEIGHT, KG

26,500

MANUFACTURER

[INA](#)

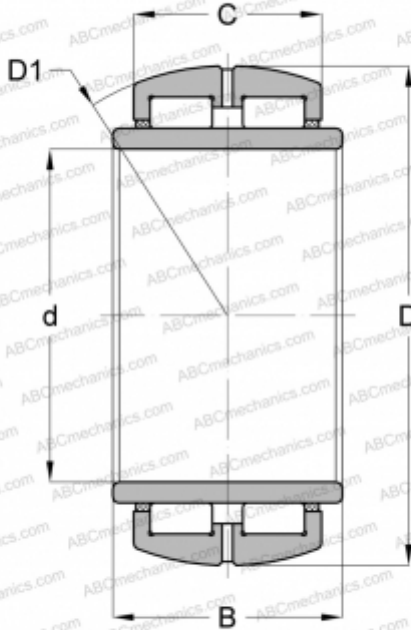

ASSOCIATED PRODUCTS

GG51290