

SL06044 E INA

Cylindrical roller bearings

TYPE: Roller bearings, Cylindrical roller bearings, Double row, Non-locating bearing, full complement cylindrical roller set, spherical outer ring

Technical specification

DIMENSIONS, MM

d	220,000
D	680,000
D1	340,000
B	150,000

WEIGHT, KG

42,000

MANUFACTURER

[INA](#)

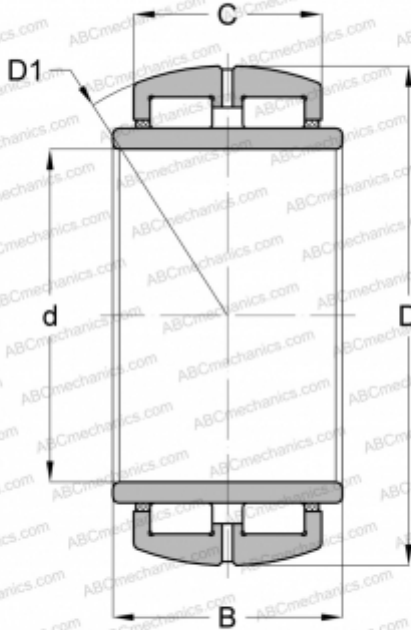

ASSOCIATED PRODUCTS

GG51340