

SL06048 E INA

Cylindrical roller bearings

TYPE: Roller bearings, Cylindrical roller bearings, Double row, Non-locating bearing, full complement cylindrical roller set, spherical outer ring

Technical specification

DIMENSIONS, MM

d	240,000
D	720,000
D1	360,000
B	155,000

WEIGHT, KG

46,000

MANUFACTURER

[INA](#)

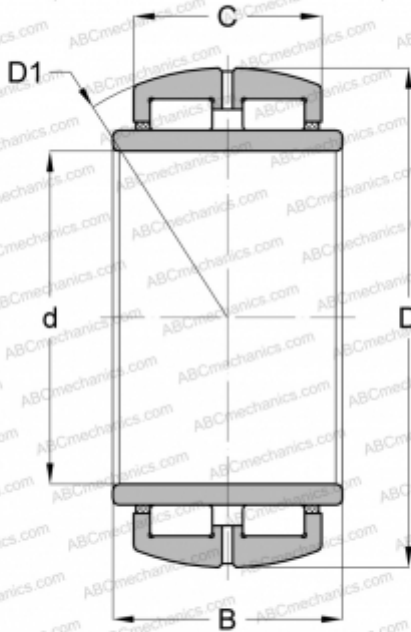

ASSOCIATED PRODUCTS

GG51360