

CPM 2542 CPM

Cylindrical roller bearings

TYPE: Roller bearings, Cylindrical roller bearings, Double row, Cardan shaft bearing, CPM production, With flange

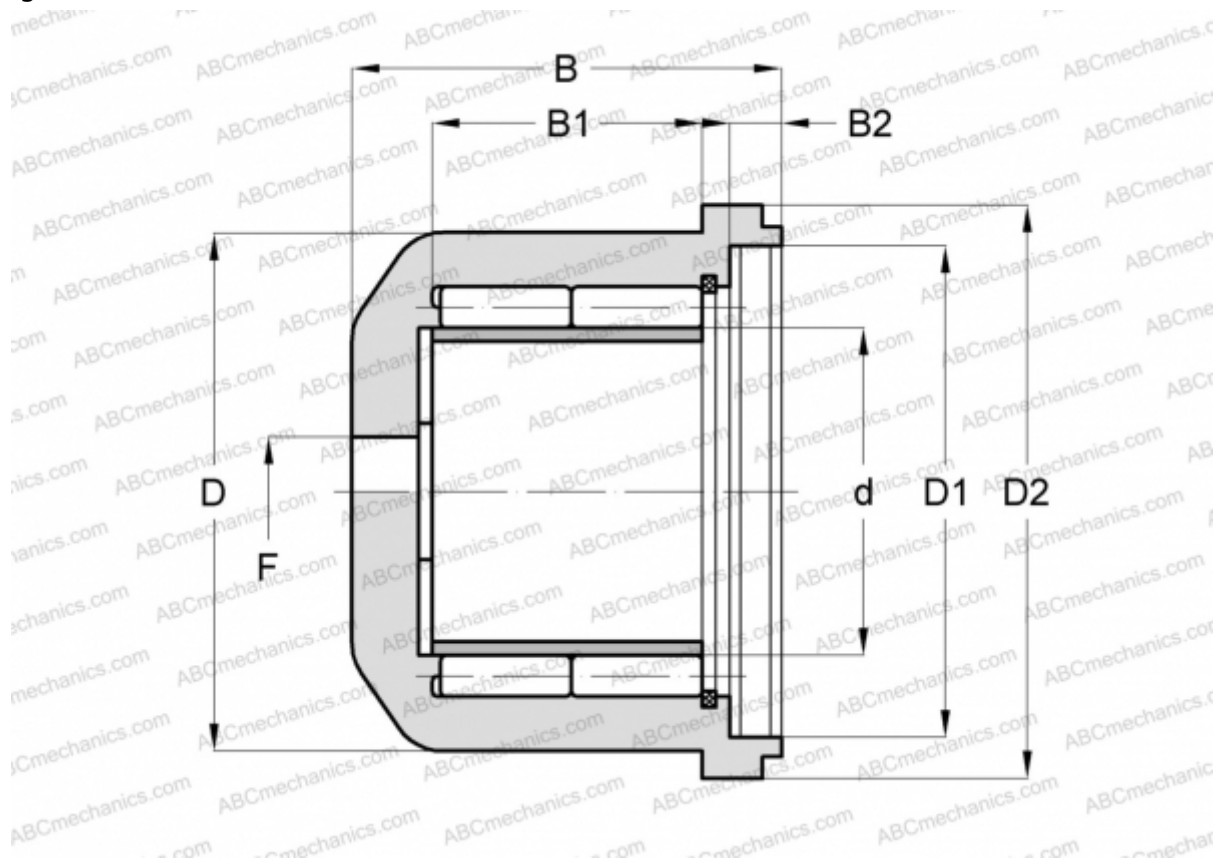

Technical specification

DIMENSIONS, MM

d	45,800
D	74,000
D1	63,000
D2	82,000
B	58,000
B1	37,500
B2	10,300

MANUFACTURER

[CPM](#)