

CPM 2692 CPM

Cylindrical roller bearings

TYPE: Roller bearings, Cylindrical roller bearings, Double row, Cardan shaft bearing, CPM production, With flange

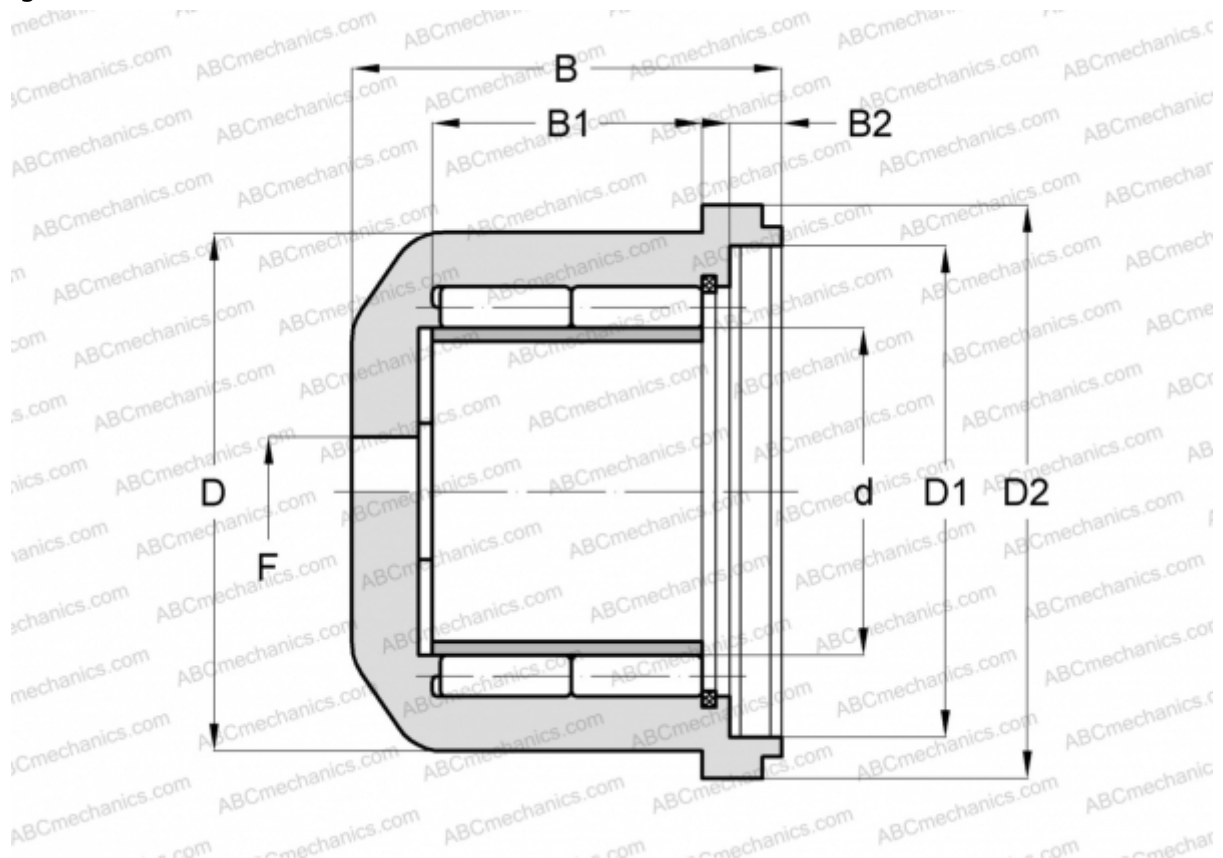

Technical specification

DIMENSIONS, MM

d	59,500
D	95,000
D1	90,000
D2	105,000
B	78,700
B1	49,500
B2	9,500
F	M10 x 1

MANUFACTURER

[CPM](#)