

CPM 2800 CPM

Cylindrical roller bearings

TYPE: Roller bearings, Cylindrical roller bearings, Double row, Cardan shaft bearing, CPM production, Without flange

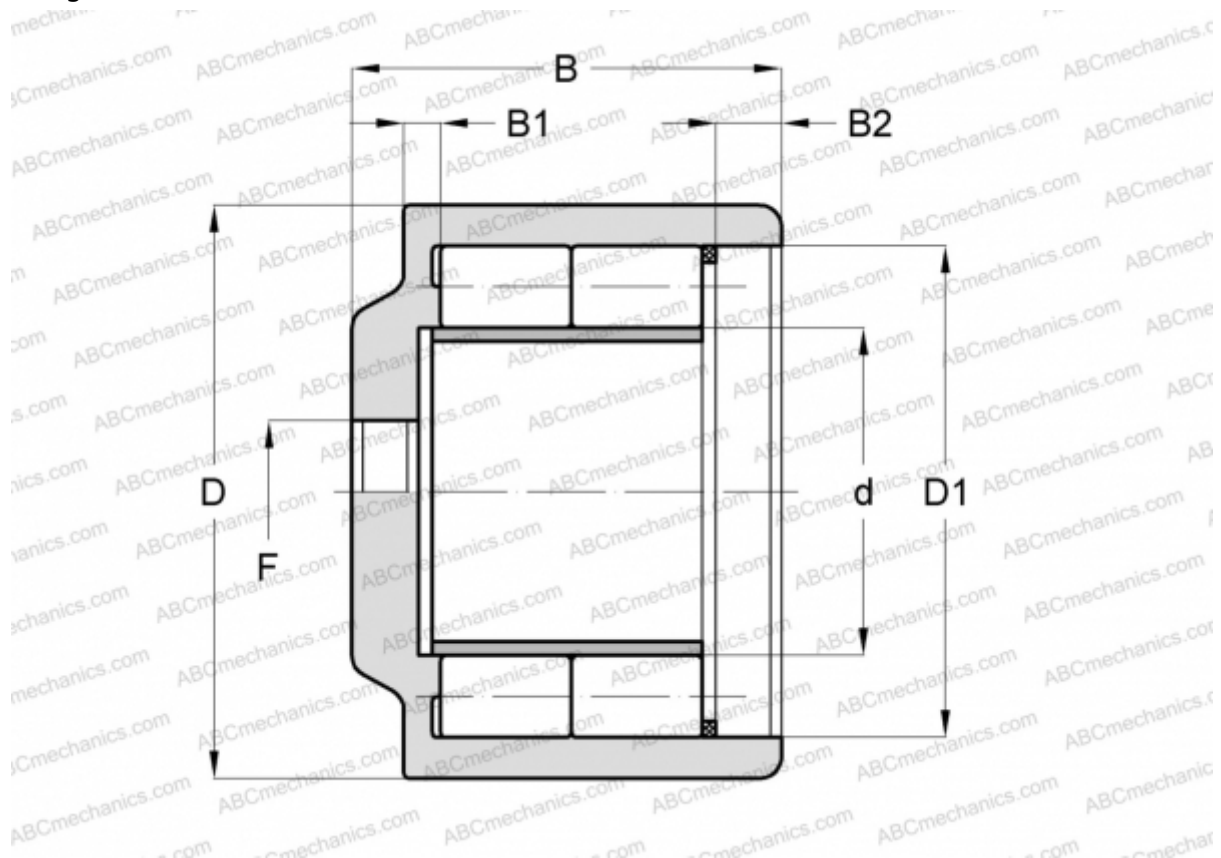

Technical specification

DIMENSIONS, MM

d	45,800
D	74,000
D1	61,800
B	54,500
B1	9,000
B2	9,000
F	M18 x 1,5

MANUFACTURER

[CPM](#)