

CPM 2803 CPM

Cylindrical roller bearings

TYPE: Roller bearings, Cylindrical roller bearings, Double row, Cardan shaft bearing, CPM production, Without flange

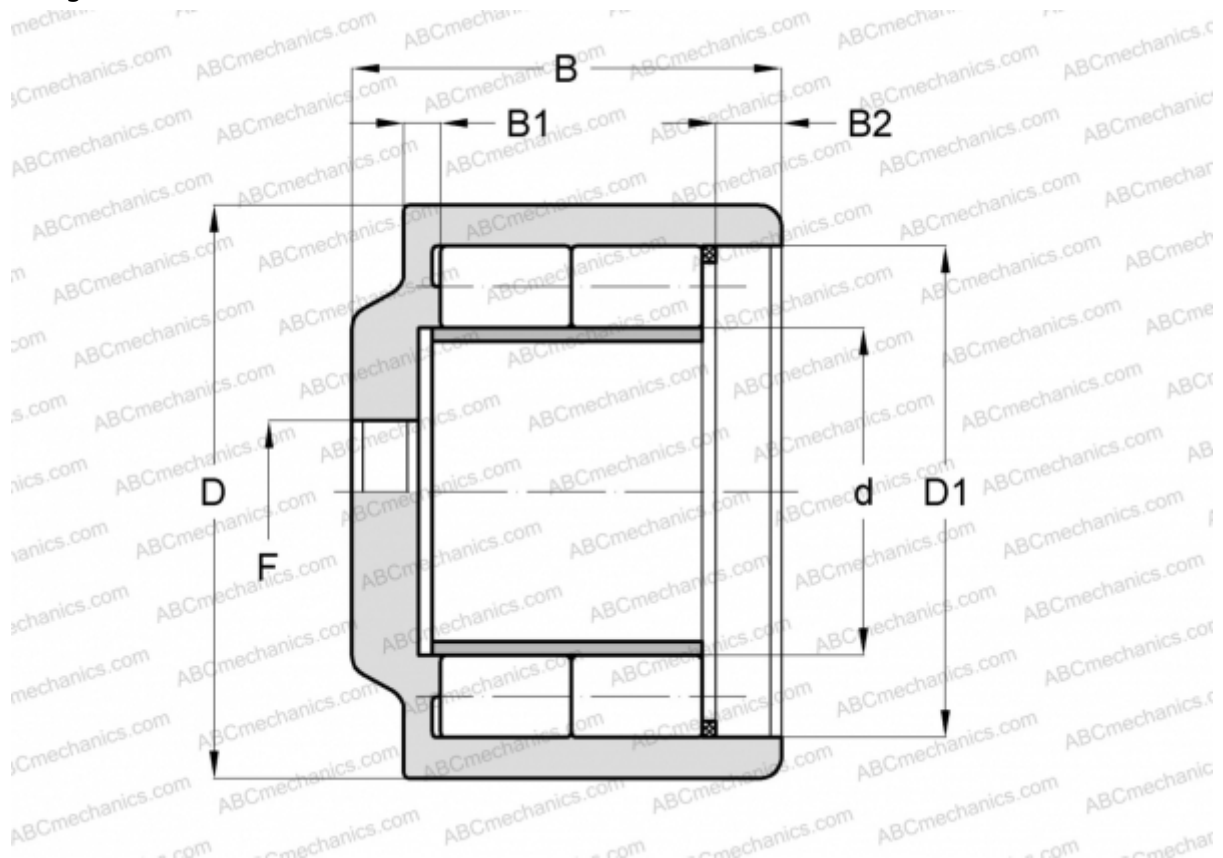

Technical specification

DIMENSIONS, MM

d	51,500
D	83,000
D1	69,500
B	61,500
B1	9,500
B2	9,500
F	M18 x 1,5

MANUFACTURER

[CPM](#)