

CPM 2747 CPM

Cylindrical roller bearings

TYPE: Roller bearings, Cylindrical roller bearings, Double row, Cardan shaft bearing, CPM production, Without flange

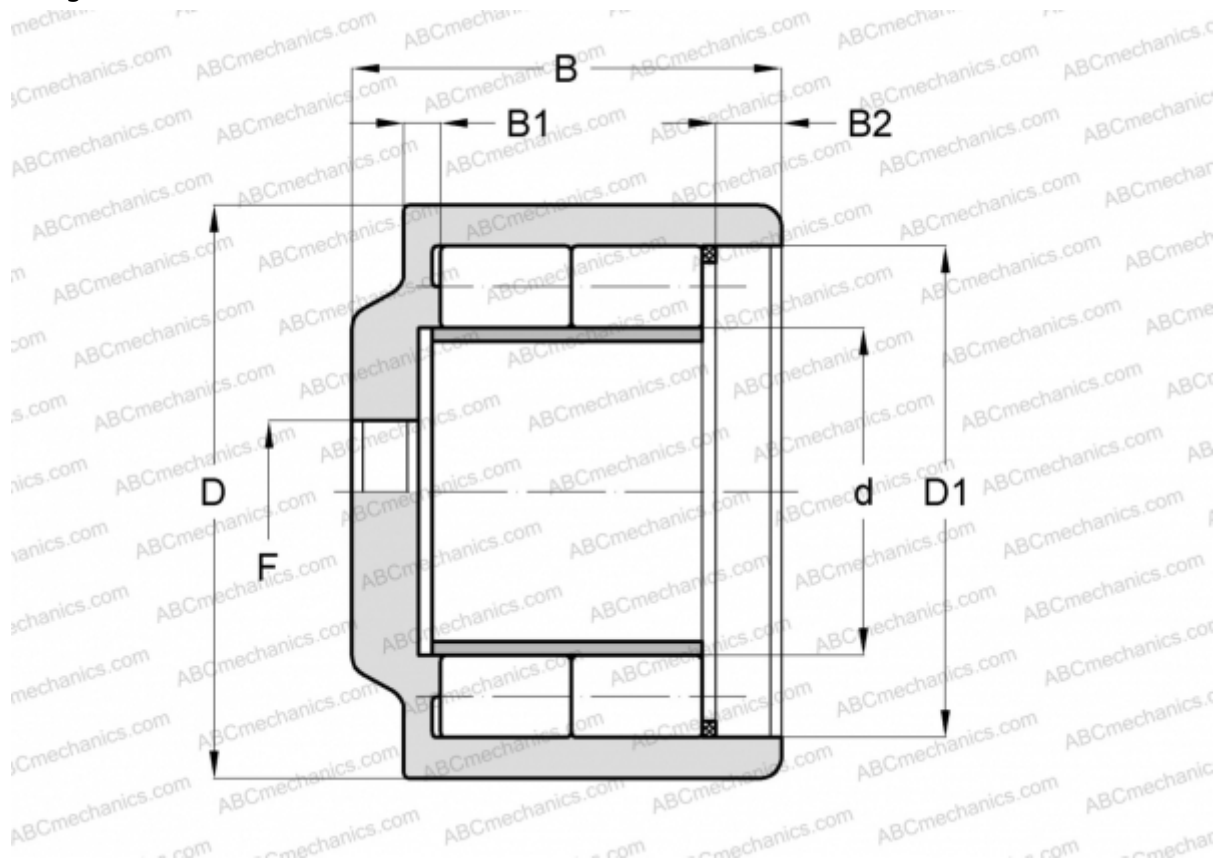

Technical specification

DIMENSIONS, MM

d	57,160
D	95,000
D1	81,160
B	69,500
B1	6,700
B2	10,500
F	M18 x 1,5

MANUFACTURER

[CPM](#)