

CPM 2686 CPM

Cylindrical roller bearings

TYPE: Roller bearings, Cylindrical roller bearings, Double row, Without outer ring, CPM production, type A, 2 flange ring, 1 locking ring

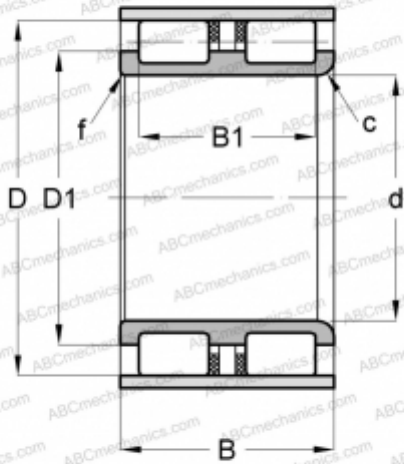

Technical specification

DIMENSIONS, MM

d	25,000
D	40,250
D1	34,300
B	26,000
B1	20,000
f	0,300
c	2,500

MANUFACTURER

[CPM](#)