

CPM 2594 CPM

Cylindrical roller bearings

TYPE: Roller bearings, Cylindrical roller bearings, Double row, Without outer ring, CPM production, type A, 2 flange ring, 1 locking ring

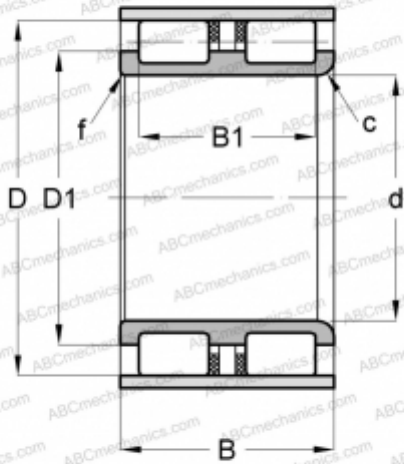

Technical specification

DIMENSIONS, MM

d	30,000
D	46,400
D1	38,700
B	32,000
B1	27,600
f	0,300
c	2,000

MANUFACTURER

[CPM](#)