

## CPM 2579 CPM

Cylindrical roller bearings

TYPE: Roller bearings, Cylindrical roller bearings, Double row, Without outer ring, CPM production, type A, 2 flange ring, 1 locking ring

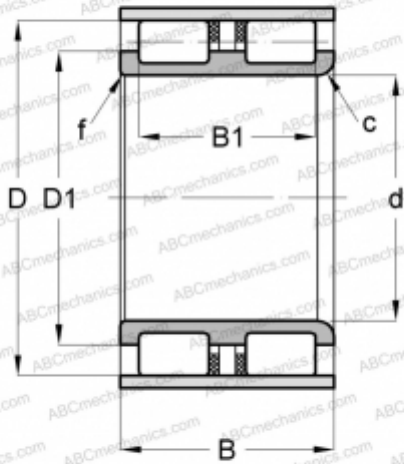

### Technical specification

#### DIMENSIONS, MM

d	32,000
D	51,750
D1	42,500
B	29,000
B1	24,000
f	0,300
c	3,000

#### MANUFACTURER

[CPM](#)