

CPM 2434 CPM

Cylindrical roller bearings

TYPE: Roller bearings, Cylindrical roller bearings, Double row, Without outer ring, CPM production, type A, 2 flange ring, 1 locking ring

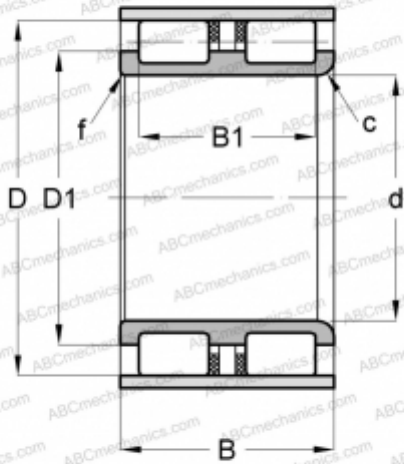

Technical specification

DIMENSIONS, MM

d	35,000
D	49,800
D1	43,900
B	28,000
B1	22,000
f	0,300
c	3,000

MANUFACTURER

[CPM](#)