

CPM 2777 CPM

Cylindrical roller bearings

TYPE: Roller bearings, Cylindrical roller bearings, Double row, Without outer ring, CPM production, type A, 2 flange ring, 1 locking ring

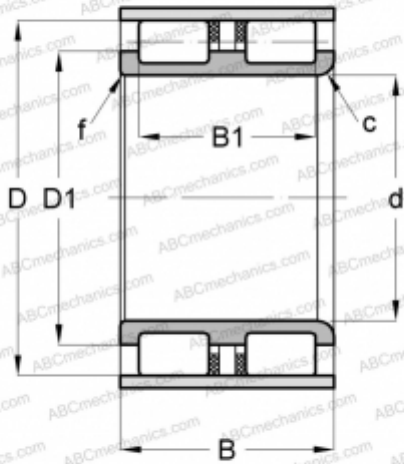

Technical specification

DIMENSIONS, MM

d	42,000
D	60,750
D1	51,500
B	37,000
B1	31,600
f	0,300
c	3,000

MANUFACTURER

[CPM](#)