

CPM 2559 CPM

Cylindrical roller bearings

TYPE: Roller bearings, Cylindrical roller bearings, Double row, Without outer ring, CPM production, type A, 2 flange ring, 1 locking ring

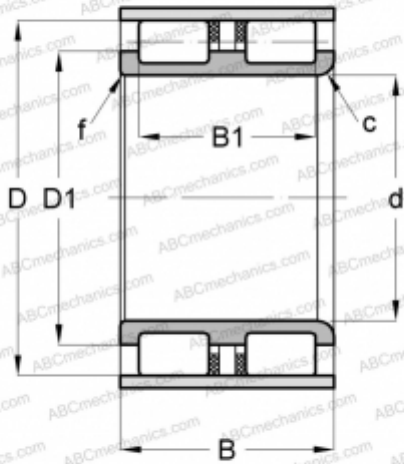

Technical specification

DIMENSIONS, MM

d	45,000
D	61,550
D1	53,800
B	32,000
B1	24,900
f	0,300
c	3,000

MANUFACTURER

[CPM](#)