

CPM 2731 CPM

Cylindrical roller bearings

TYPE: Roller bearings, Cylindrical roller bearings, Double row, Without outer ring, CPM production, type A, 2 flange ring, 1 locking ring

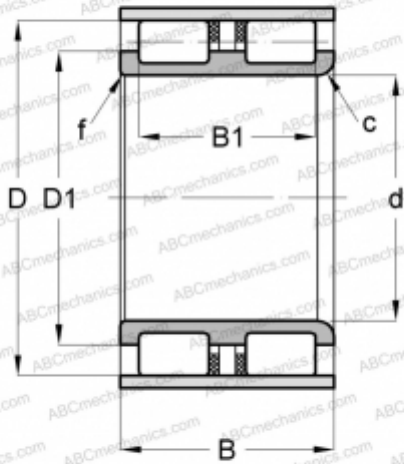

Technical specification

DIMENSIONS, MM

d	55,000
D	85,070
D1	66,000
B	41,000
B1	33,800
f	0,300
c	3,000

MANUFACTURER

[CPM](#)