

## CPM 2656 CPM

Cylindrical roller bearings

TYPE: Roller bearings, Cylindrical roller bearings, Double row, Without outer ring, CPM production, type A, 2 flange ring, 1 locking ring

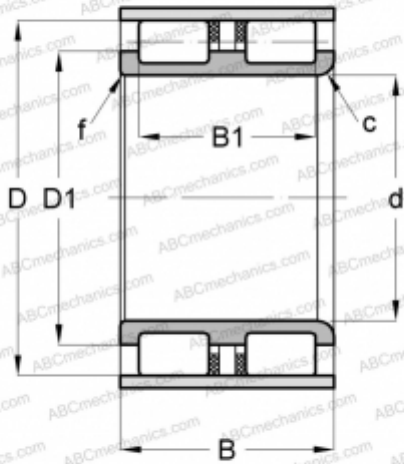

### Technical specification

#### DIMENSIONS, MM

d	65,000
D	89,800
D1	78,500
B	48,000
B1	40,600
f	0,300
c	4,000

#### MANUFACTURER

[CPM](#)