

CPM 2610 CPM

Cylindrical roller bearings

TYPE: Roller bearings, Cylindrical roller bearings, Double row, Without outer ring, CPM production, type A, 2 flange ring, 1 locking ring

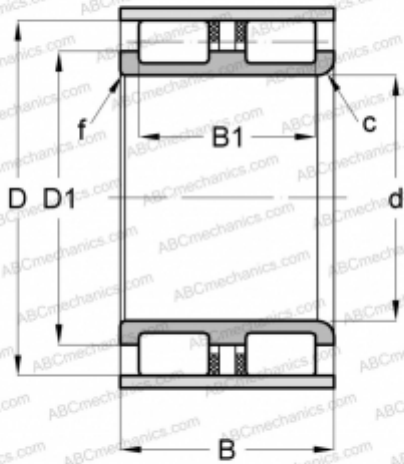

Technical specification

DIMENSIONS, MM

d	80,000
D	112,750
D1	93,100
B	60,000
B1	50,000
f	1,100
c	1,100

MANUFACTURER

[CPM](#)