

CPM 2657 CPM

Cylindrical roller bearings

TYPE: Roller bearings, Cylindrical roller bearings, Double row, Without outer ring, CPM production, type A, 2 flange ring, 1 locking ring

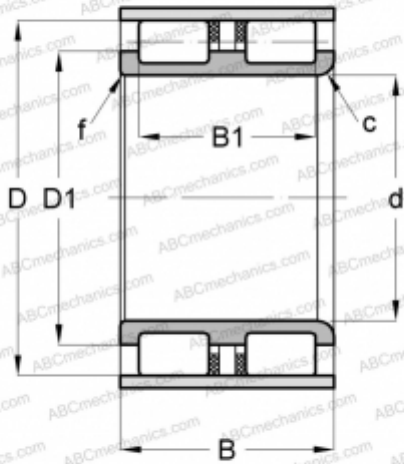

Technical specification

DIMENSIONS, MM

d	80,000
D	122,100
D1	96,000
B	70,000
B1	60,000
f	0,300
c	4,200

MANUFACTURER

[CPM](#)