

800426 FAG

Cylindrical roller bearings

TYPE: Roller bearings, Cylindrical roller bearings, Four row, For loose fit on the roll neck, design 5 (FAG)

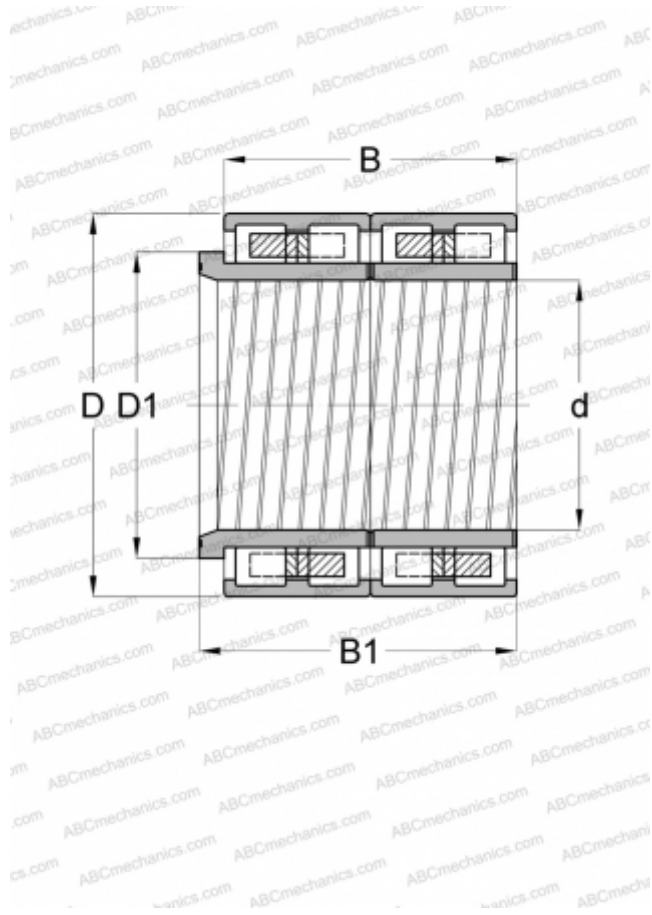

Technical specification

DIMENSIONS, MM

d	200,000
D	310,000
D1	229,000
B	230,000
B1	260,000

WEIGHT, KG

64,900

MANUFACTURER

[FAG](#)