

579713 FAG

Cylindrical roller bearings

TYPE: Roller bearings, Cylindrical roller bearings, Four row, For loose fit on the roll neck, design 5 (FAG)

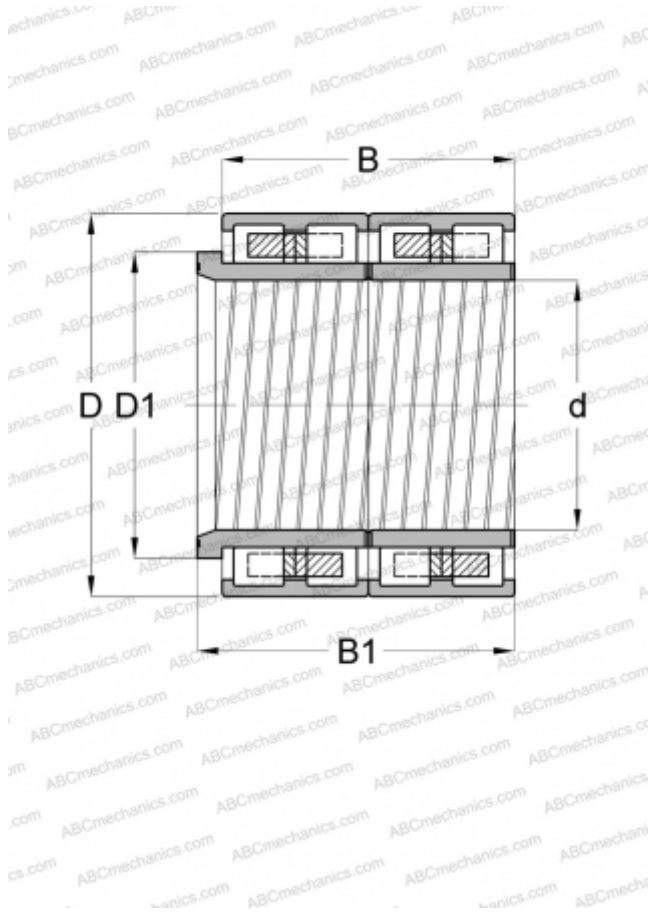

Technical specification

DIMENSIONS, MM

d	530,000
D	760,000
D1	587,000
B	520,000
B1	555,000

WEIGHT, KG

809,000

MANUFACTURER

[FAG](#)