

J-128 NSK

Needle roller bearings

TYPE: Roller bearings, Needle, Single row, Drawn cup, with cage, with open ends, type J, JH (NSK), inch size

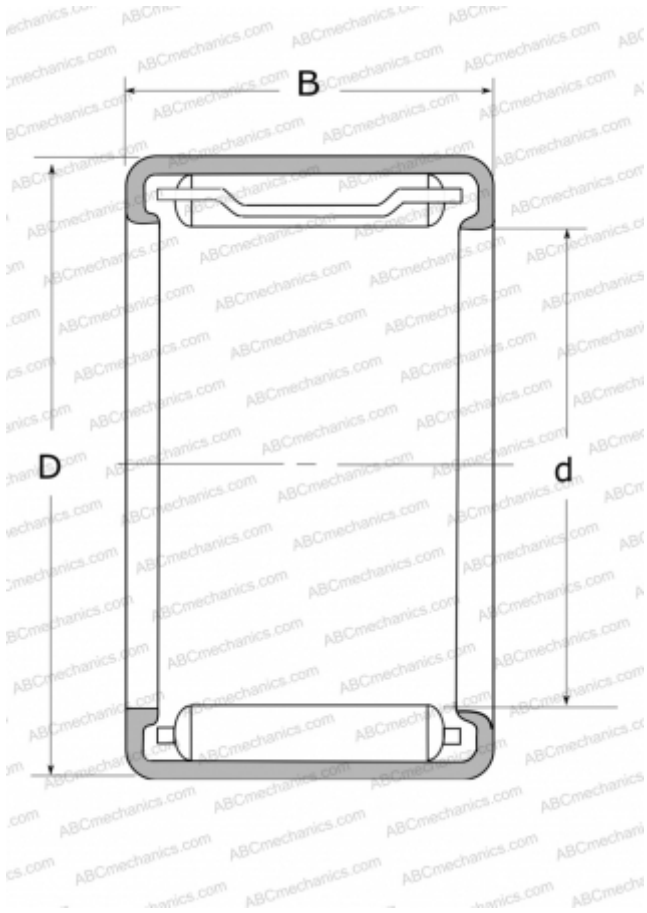

Technical specification

DIMENSIONS, MM

d	19,050
D	25,400
B	12,700

WEIGHT, KG

0,012

MANUFACTURER

[NSK](#)

ASSOCIATED PRODUCTS

IR-88