

J-1812 NSK

Needle roller bearings

TYPE: Roller bearings, Needle, Single row, Drawn cup, with cage, with open ends, type J, JH (NSK), inch size

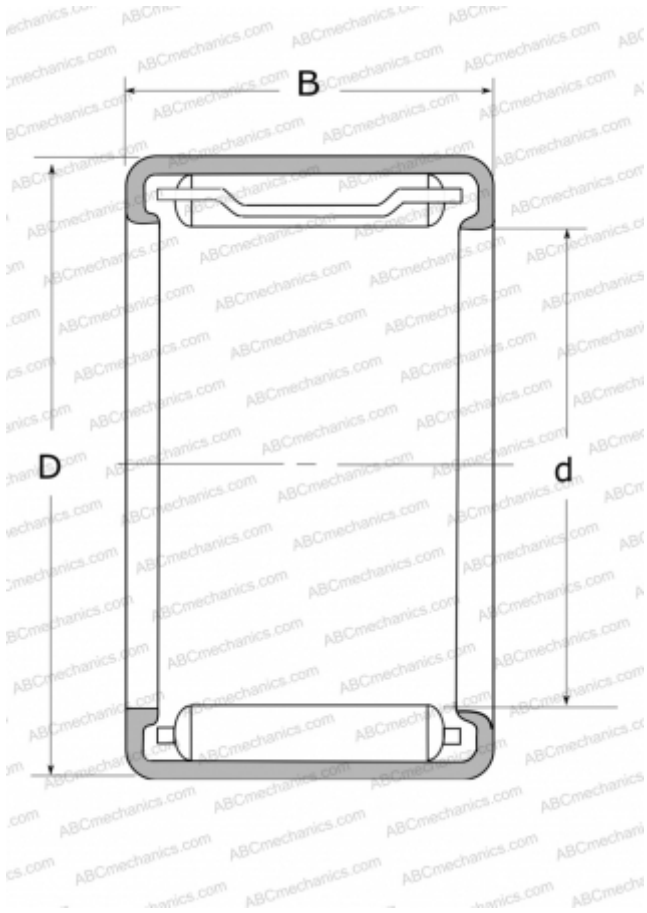

Technical specification

DIMENSIONS, MM

d	28,575
D	34,925
B	19,050

WEIGHT, KG

0,030

MANUFACTURER

[NSK](#)