

JH-1816 NSK

Needle roller bearings

TYPE: Roller bearings, Needle, Single row, Drawn cup, with cage, with open ends, type J, JH (NSK), inch size

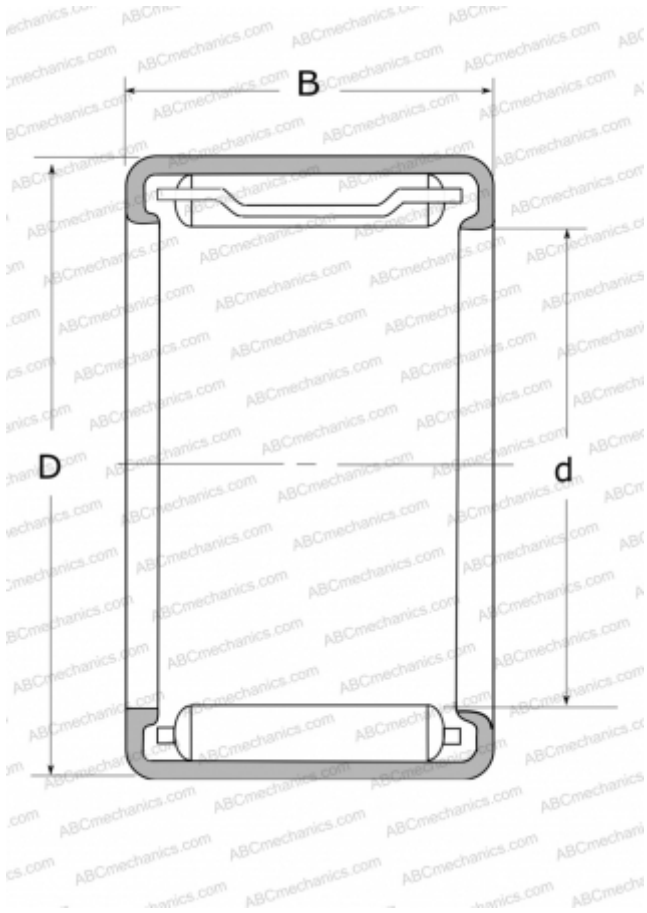

Technical specification

DIMENSIONS, MM

d	28,575
D	38,100
B	25,400

WEIGHT, KG

0,062

MANUFACTURER

[NSK](#)

ASSOCIATED PRODUCTS

IR-1416