

JH-2020 NSK

Needle roller bearings

TYPE: Roller bearings, Needle, Single row, Drawn cup, with cage, with open ends, type J, JH (NSK), inch size

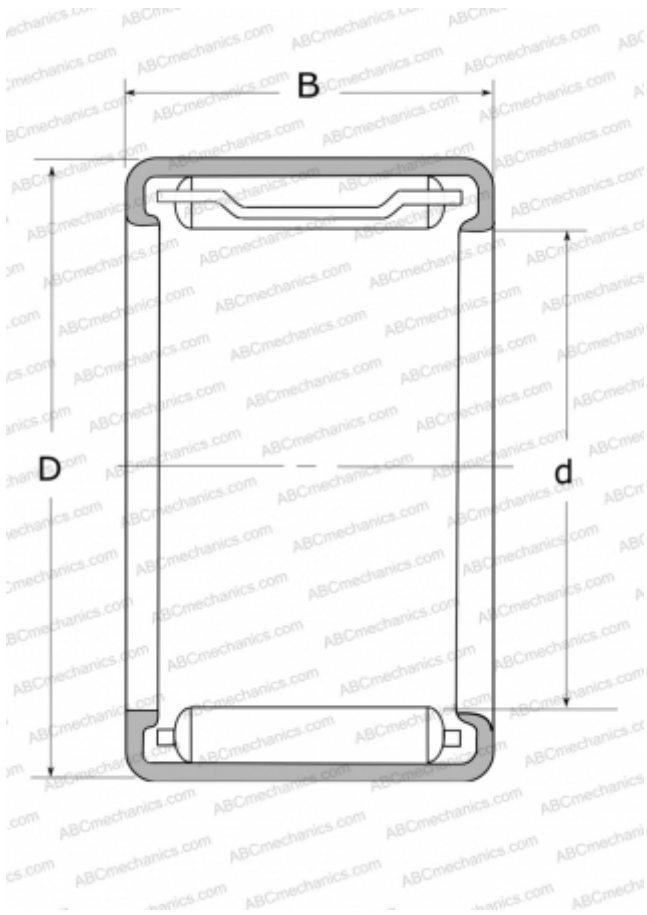

Technical specification

DIMENSIONS, MM

d	31,750
D	41,275
B	31,750

WEIGHT, KG

0,075

MANUFACTURER

[NSK](#)