

J-3016 NSK

Needle roller bearings

TYPE: Roller bearings, Needle, Single row, Drawn cup, with cage, with open ends, type J, JH (NSK), inch size

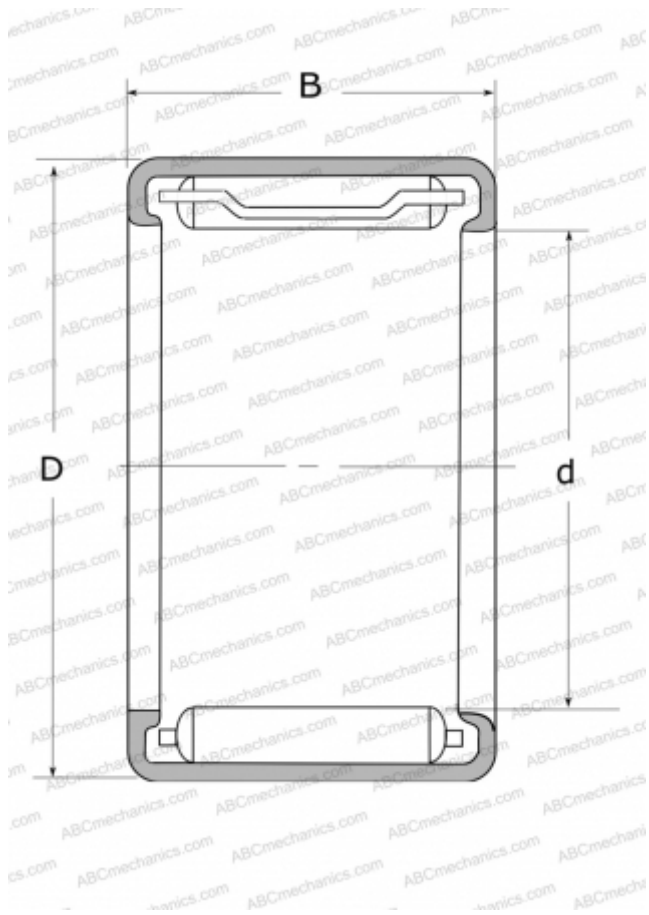

Technical specification

DIMENSIONS, MM

d	47,625
D	57,150
B	25,400

WEIGHT, KG

0,096

MANUFACTURER

[NSK](#)