

RBY 1 ABC

Yoke type track roller

TYPE: Roller bearings, Yoke type track rollers, With axial guidance, Double row roller set, contact seals on both side, cylindrical outer ring, inch size

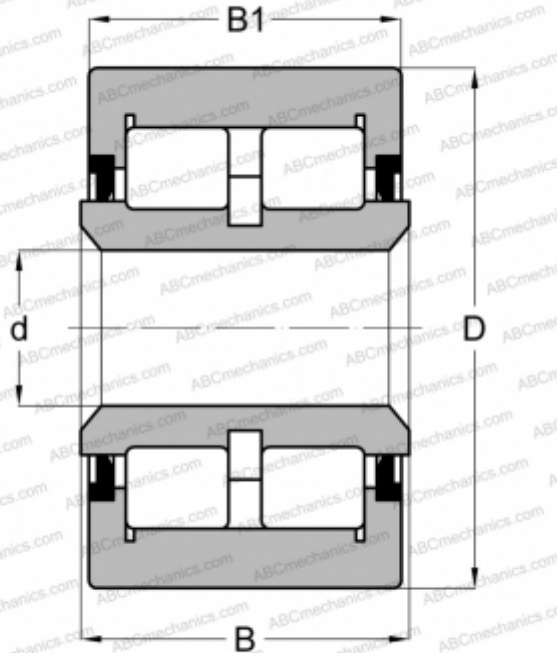

Technical specification

DIMENSIONS, MM

d	7,925
D	25,400
B	17,577
B1	15,875

WEIGHT, KG

0,052

MANUFACTURER

[ABC](#)

INTERCHANGE

CONSOLIDATED

[YCRSR 16](#)