

RBY 1 3/8 ABC

Yoke type track roller

TYPE: Roller bearings, Yoke type track rollers, With axial guidance, Double row roller set, contact seals on both side, cylindrical outer ring, inch size

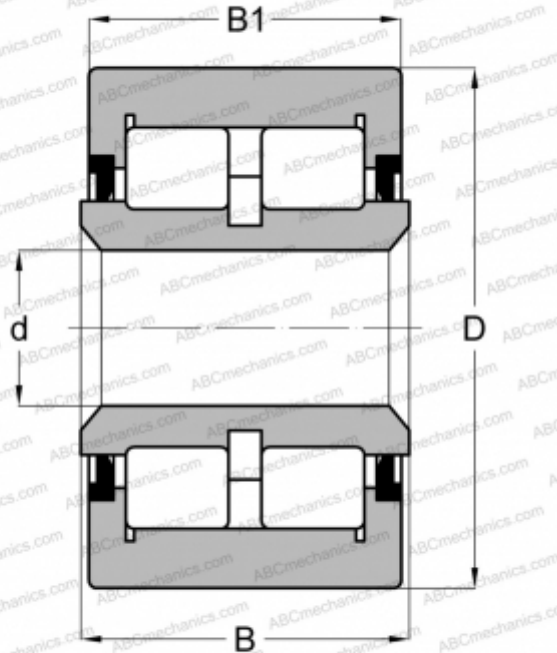

Technical specification

DIMENSIONS, MM

d	9,525
D	34,925
B	20,625
B1	19,050

WEIGHT, KG

0,127

MANUFACTURER

[ABC](#)

INTERCHANGE

CONSOLIDATED

[YCRSR 22](#)