

RBY 1 7/8 ABC

Yoke type track roller

TYPE: Roller bearings, Yoke type track rollers, With axial guidance, Double row roller set, contact seals on both side, cylindrical outer ring, inch size

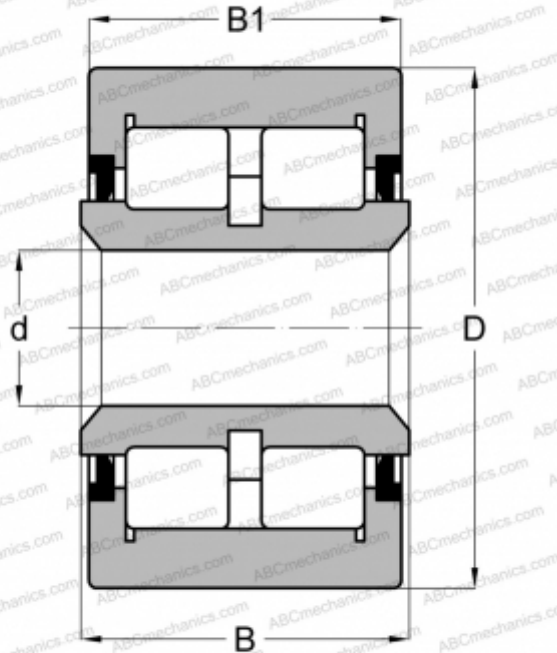

Technical specification

DIMENSIONS, MM

d	12,700
D	47,625
B	26,975
B1	25,400

WEIGHT, KG

0,304

MANUFACTURER

[ABC](#)

INTERCHANGE

CONSOLIDATED

[YCRSR 30](#)