

RBY 3 1/2 ABC

Yoke type track roller

TYPE: Roller bearings, Yoke type track rollers, With axial guidance, Double row roller set, contact seals on both side, cylindrical outer ring, inch size

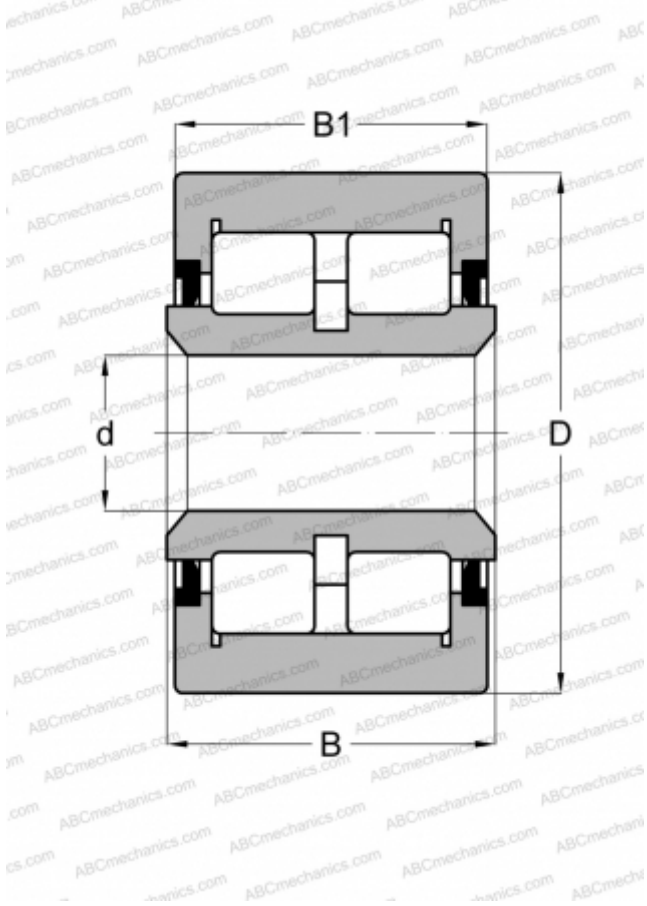

Technical specification

DIMENSIONS, MM

d	28,575
D	88,900
B	52,375
B1	50,800

WEIGHT, KG

2,041

MANUFACTURER

[ABC](#)

INTERCHANGE

CONSOLIDATED

[YCRSR 56](#)