

RBY 8 ABC

Yoke type track roller

TYPE: Roller bearings, Yoke type track rollers, With axial guidance, Double row roller set, contact seals on both side, cylindrical outer ring, inch size

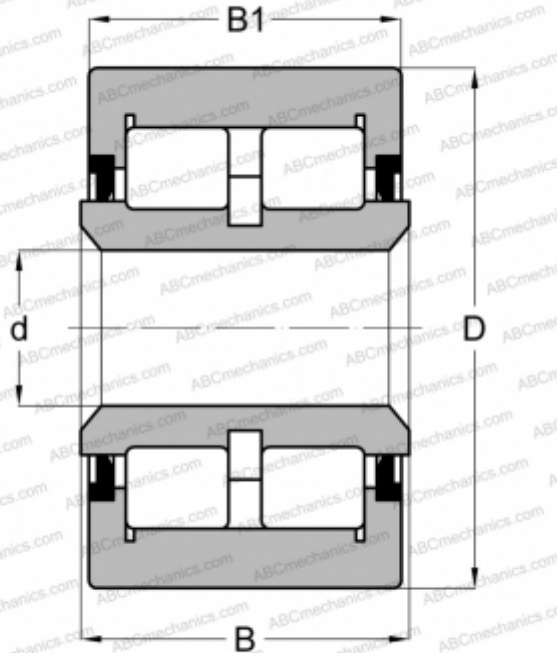

Technical specification

DIMENSIONS, MM

d	82,550
D	203,200
B	114,300
B1	107,950

WEIGHT, KG

21,092

MANUFACTURER

[ABC](#)

INTERCHANGE

CONSOLIDATED

[YCRSR 128](#)