

RBY 9 ABC

Yoke type track roller

TYPE: Roller bearings, Yoke type track rollers, With axial guidance, Double row roller set, contact seals on both side, cylindrical outer ring, inch size

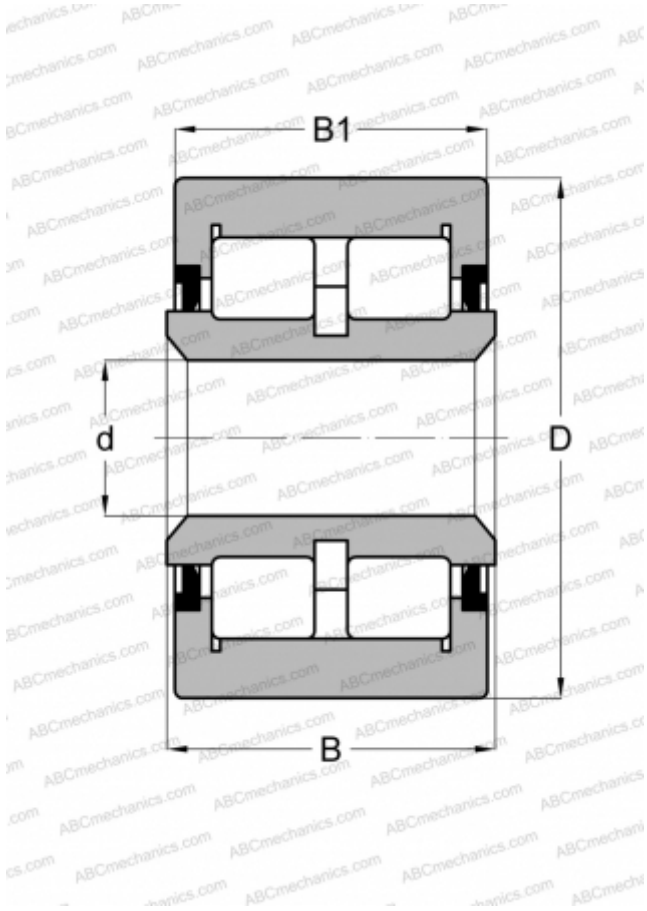

Technical specification

DIMENSIONS, MM

d	95,250
D	228,600
B	127,000
B1	120,650

WEIGHT, KG

29,484

MANUFACTURER

[ABC](#)

INTERCHANGE

CONSOLIDATED

[YCRSR 144](#)