

YCRSCR 18 CONSOLIDATED

Yoke type track roller

TYPE: Roller bearings, Yoke type track rollers, With axial guidance, Double row roller set, contact seals on both side, inch size

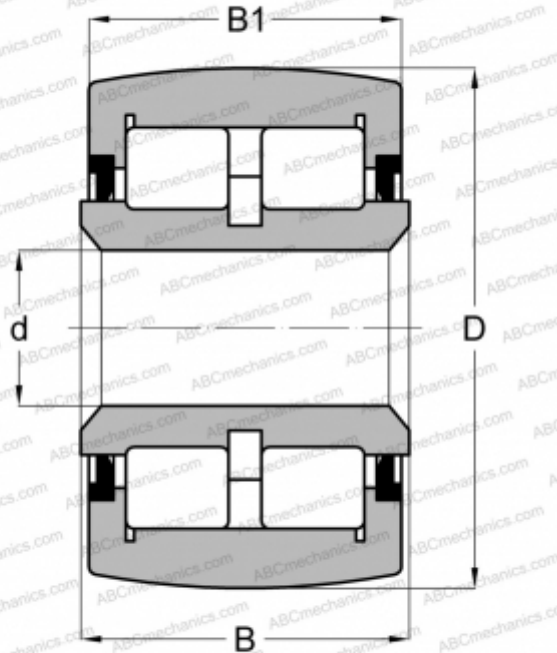

Technical specification

DIMENSIONS, MM

d	7,925
D	28,575
B	17,577
B1	15,875

WEIGHT, KG

0,068

MANUFACTURER

[CONSOLIDATED](#)

INTERCHANGE

ABC

[CRBY 1 1/8](#)