

YCRSCR 26 CONSOLIDATED

Yoke type track roller

TYPE: Roller bearings, Yoke type track rollers, With axial guidance, Double row roller set, contact seals on both side, inch size

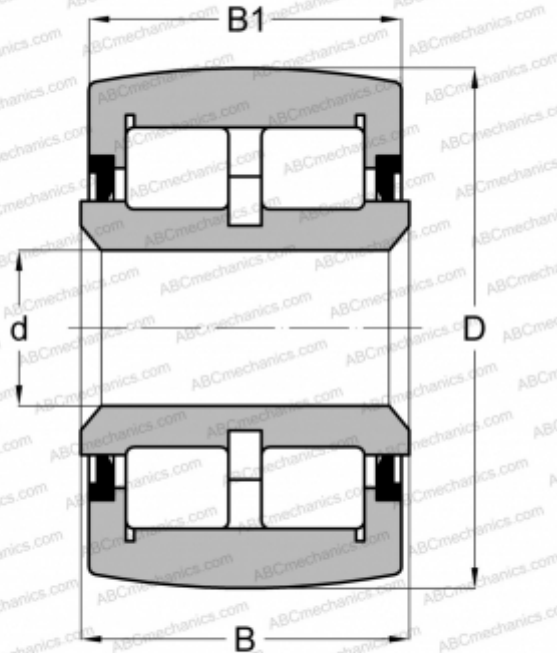

Technical specification

DIMENSIONS, MM

d	11,100
D	41,275
B	23,800
B1	22,225

WEIGHT, KG

0,200

MANUFACTURER

[CONSOLIDATED](#)

INTERCHANGE

ABC

[CRBY 1 5/8](#)