

YCRSCR 30 CONSOLIDATED

Yoke type track roller

TYPE: Roller bearings, Yoke type track rollers, With axial guidance, Double row roller set, contact seals on both side, inch size

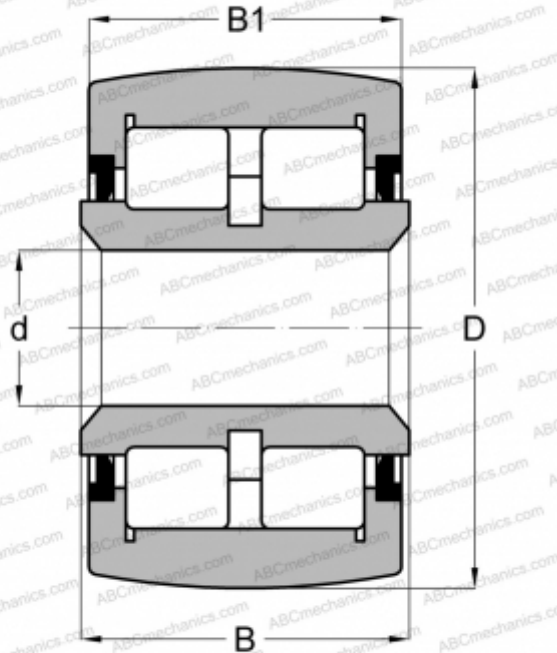

Technical specification

DIMENSIONS, MM

d	12,700
D	47,625
B	26,924
B1	25,400

WEIGHT, KG

0,304

MANUFACTURER

[CONSOLIDATED](#)

INTERCHANGE

ABC

[CRBY 1 7/8](#)